

MOTOR FEATURES

REFERENCE NUMBER REFERENCIA REFERENZNUMMERN	NOMINAL VOLTAGE TENSION NOMINAL NENNSPANNUNG	NOMINAL TORQUE PAR NOMINAL DREHMOMENT NOMINAL	NOMINAL SPEED VELOCIDAD NOMINAL VITESSE NOMINALE GESCHWINDIGKEIT NOMINAL	NOMINAL CURRENT CORRIENTE NOMINAL COURANT NOMINAL NOMINALSTROM	STARTING TORQUE PAR DE ARRANQUE COUPLE DE DEMARRAGE ANZUGSDREHMOMENT	STARTING CURRENT CORRIENTE DE ARRANQUE COURANT DE DEMARRAGE ANLAUFSTROM	SHAFT EJE ARBRE WELLE	CONNECTIONS CONEXIONES CONNEXIONS ANSCHLUSSART	WIRING DIAGRAM ESQUEMA ELECTRICO SCHEMA ELECTRIQUE SCHALTBIELD	TRANSMISSION RATIO RELACION DE REDUCCION RAPPORT DE REDUCTEUR UNTERSATZUNG	APPROXIMATE WEIGHT PESO APROXIMADO POIDS APPROXIMATIF GEWICHT (ca.)	WATERTIGHTNESS GRADO DE ESTANQUEIDAD ETANCHÉITÉ FEUCHTIGKEITSSCHUTZKLASSE	WHEEL MATERIAL MATERIAL RUEDA MATERIAU ROUE MAT. DES SCHNECKENRADES	CURVE CURVA COURBE KURVE
	Un (V)	Mn (N.m./lbf.in)	nn (r.p.m.)	In (A)	Ma (N.m./lbf.in)	Ia (A)				i	P (kg/lb)	IP		
31627112000	12	2 / 17.70	38	3.4	10 / 88.5	12	E22	C30	EE4	62:1	0.90 / 1.98	IP10	PLA	56
31627113000	24	2 / 17.70	38	1.7	10 / 88.5	6	E22	C30	EE4	62:1	0.90 / 1.98	IP10	PLA	56
31627612000	12	2 / 17.70	38	3.4	10 / 88.5	12	E30	C30	EE4	62:1	0.90 / 1.98	IP10	PLA	56
31627613000	24	2 / 17.70	38	1.7	10 / 88.5	6	E30	C30	EE4	62:1	0.90 / 1.98	IP10	PLA	56
31627612000E	12	2 / 17.70	38	3.4	10 / 88.5	12	E30	C30	F4	62:1	0.90 / 1.98	IP10	PLA	56
31627613000E	24	2 / 17.70	38	1.7	10 / 88.5	6	E30	C30	F4	62:1	0.90 / 1.98	IP10	PLA	56
31697283000	24	2 / 17.70	38	1.7	10 / 88.5	6	E30	C30	EE4	62:1	0.90 / 1.98	IP10	BRO	56
31697312000	12	*1.5 / 13.27	65	6.0	10 / 88.5	22	E30	C30	EE4	62:1	0.90 / 1.98	IP10	PLA	57
31697313000	24	*1.5 / 13.27	65	3.0	10 / 88.5	11	E30	C30	EE4	62:1	0.90 / 1.98	IP10	PLA	57

* (VDE 0530) S3 - 10% (10 min.)

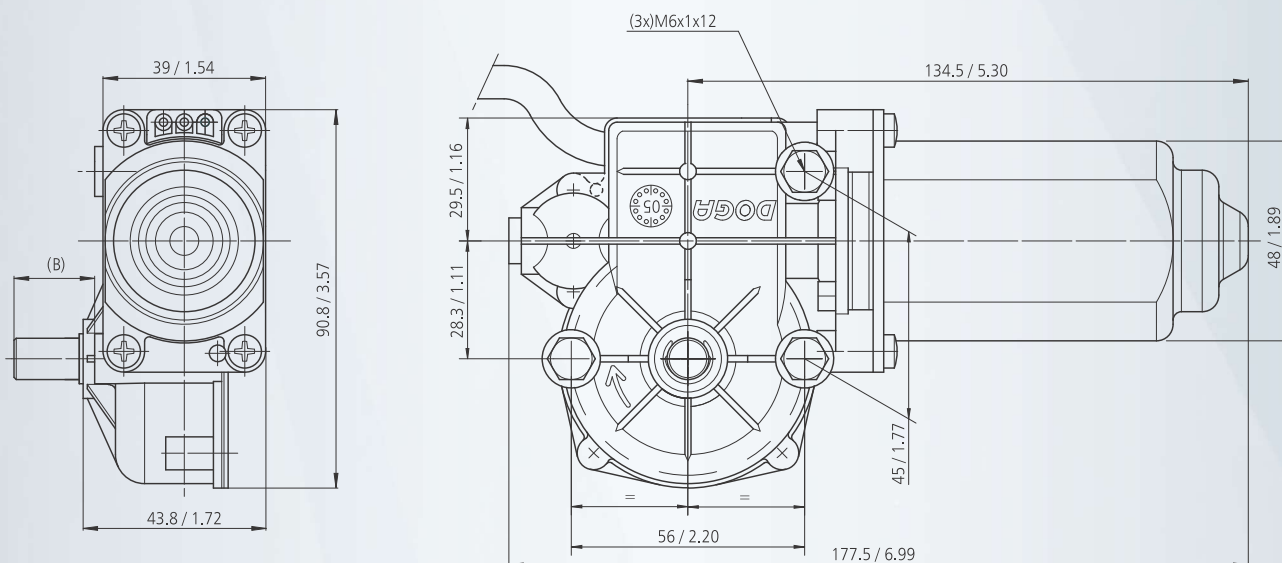

mm / inch

SHAFT **EJE** ARBRE **WELLE**

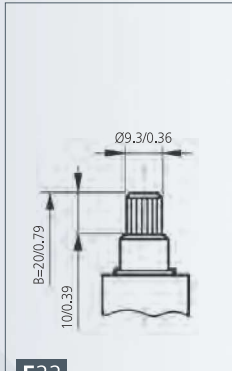

E22

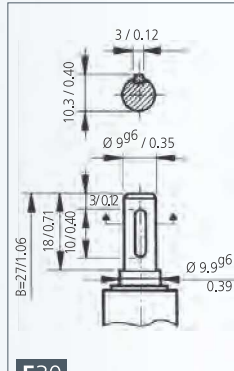

E30

CONNECTIONS **CONEXIONES** CONNEXIONS **ANSCHLUSSART**

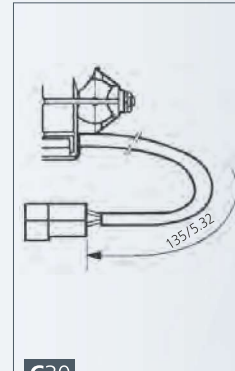

C30

WIRING DIAGRAM **ESQUEMA ELÉCTRICO** SCHEMA ÉLECTRIQUE **SCHALTBILD**

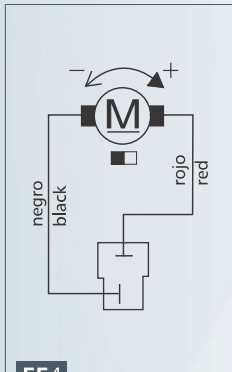

EE4

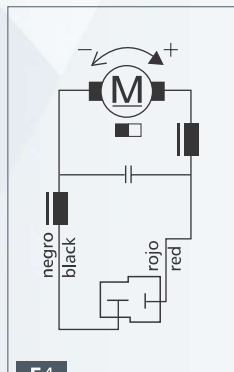

F4

CURVES **CURVAS** COURBES **KURVEN**

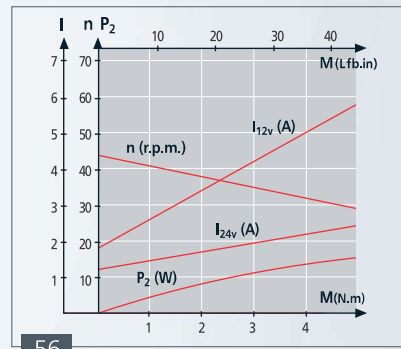

56

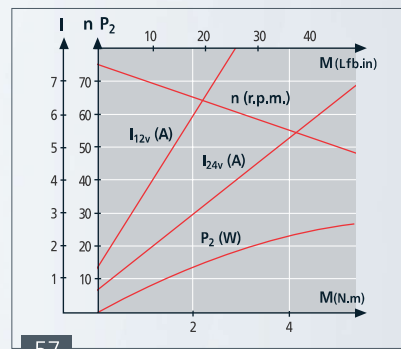

57